



SDM120-Modbus

Single-Phase Multifunction DIN rail Meter



- Measures kWh, Kvarh, KW, Kvar, KVA, PF, Hz, dmd, V, A, etc.
- Bi-directional measurement IMP & EXP
- Two pulse outputs
- RS485 Modbus
- Din rail mounting 17.5mm
- 45A direct connection
- Better than Class 1 accuracy

User Manual V2.6

2016

Application

The energy-meters “with a blue back-lighted LCD screen for perfect reading” are used to measure single-phase like residential, utility and Industrial application. The unit measures and displays various important electrical parameters, and provide a RS485 communication port for remote reading and monitoring. Bi-directional energy measurement makes the unit a good choice for solar PV energy metering. The compact design and din rail installation provides a easy and economical solution for your metering demand.

General Specifications

Voltage AC (Un)	230V
Voltage Range	176~276V AC
Base Current (Ib)	5A
Max. Current (Imax)	45A
Mini Current (Imin)	0.25A
Starting current	0.4% of Ib
Power consumption	<2W/10VA
Frequency	50/60Hz(±10%)
AC voltage withstand	4KV for 1 minute
Impulse voltage withstand	6KV-1.2uS waveform
Overcurrent withstand	30Imax for 0.01s
Pulse output rate	1000imp/kWh (default) 100/10/1 imp/kWh/kVarh (configurable)
Display	LCD with blue backlit
Max. Reading	99999.9kWh

Accuracy

Voltage	0.5% of range maximum
Current	0.5% of nominal
Frequency	0.2% of mid-frequency
Power factor	1% of Unity
Active power	1% of range maximum
Reactive power	1% of range maximum
Apparent power	1% of range maximum
Active energy	Class 1 IEC62053-21 Class B EN50470-3
Reactive energy	1% of range maximum

Environment

Operating temperature	-25°C to +55°C
Storage and transportation temperature	-40°C to +70°C
Reference temperature	23°C ± 2°C
Relative humidity	0 to 95%, non-condensing
Altitude	up to 2500m
Warm up time	10s
Installation category	CAT II
Mechanical Environment	M1
Electromagnetic environment	E2
Degree of pollution	2

Output

Pulse Output

The meter provides two pulse outputs. Both pulse outputs are passive type.

Pulse output 1 is configurable. The pulse output can be set to generate pulses to represent total / import/export kWh or kVarh.

The pulse constant can be set to generate 1 pulse per: 0.001(default) / 0.01/0.1/kWh/kVarh.

Pulse width: 200/100/60ms

Pulse output 2 is non-configurable. It is fixed up with total kWh. The constant is 1000imp/kWh.

RS485 output for Modbus RTU

The meter provides a RS485 port for remote communication. Modbus RTU is the protocol applied. For Modbus RTU, the following RS485 communication parameters can be configured from the Set-up menu.

Baud rate: 1200, 2400, 4800, 9600

Parity: NONE/EVEN/ODD

Stop bits: 1 or 2



Modbus Address: 1 to 247

Mechanics

Din rail dimensions	17.5x119x62 (WxHxD) DIN 43880
Mounting	DIN rail 35mm
Sealing	IP51 (indoor)
Material	self-extinguishing UL94V-0

Initialization Display

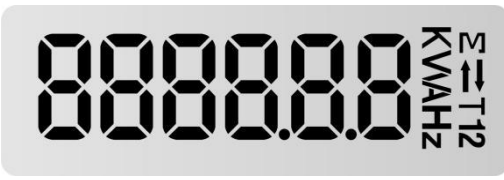
When it is powered on, the meter will initialize and do self-checking.



1		Full Screen It will last for 3 seconds.
2		Software version It will last for 3 seconds.







After the self-checking program, the meter display will show the total active energy (kWh)

Scroll Display by button

There is a button on the front of the meter. After initialization and self-checking program, the meter display the measured values. The default page is total kWh. If the user wants to check other information, he needs to press the scroll button on the front panel.

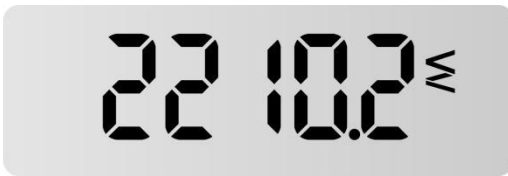
	Click the button, the LCD display will scroll the measurements. Keep pressing the button for 3 seconds, the meter will get into set-up mode.
---	---

1		Total active energy (kWh) Display format: 0000.00→9999.99→10000.0→99999.9→0000.00
1-1		Import active energy (kWh) Display format: 0000.00→9999.99→10000.0→99999.9→0000.00
1-2		Export active energy (kwh) Display format: 0000.00→9999.99→10000.0→99999.9→0000.00

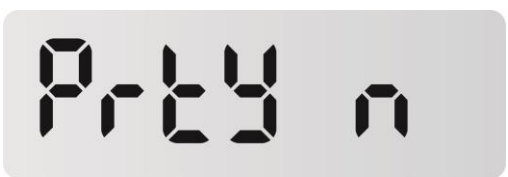
2		Voltage (V)
3		Current (A)
4		Active power (W)
5		Frequency (F)
6		Power factor (PF)
7		Modbus Address (ID) Default: 001
8		Baud rate Default : 2400bps
9		Parity None/even/odd are optional Default: none

Set-up Mode

To get into Set-up Mode, the user need keep pressing the button for 3 seconds, the meter LCD will shows “-SET-”.



The user can program the meter parameters by sending correct command via RS485 port. The protocol is Modbus RTU. For the details. Please look at the “Eastron SDM120-Modbus protocol”.

Wiring diagram

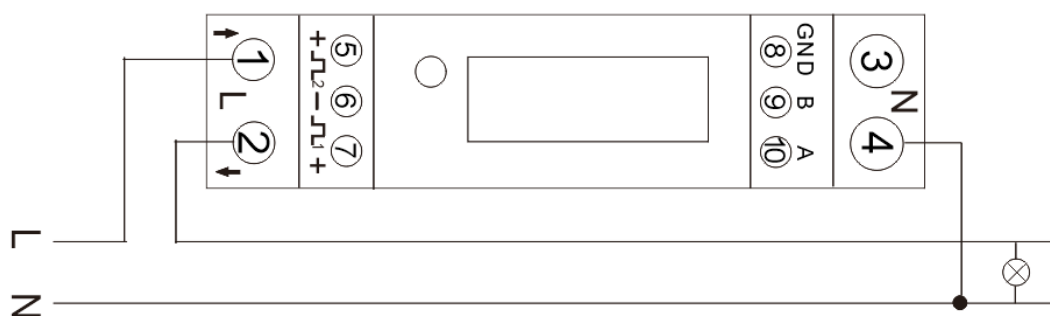

1: L-in 2: L-out 3 / 4: N 5 / 6 / 7: PO 2+ / Com / PO 1+ 8 / 9 / 10: GND/RS485 B/A

Dimensions

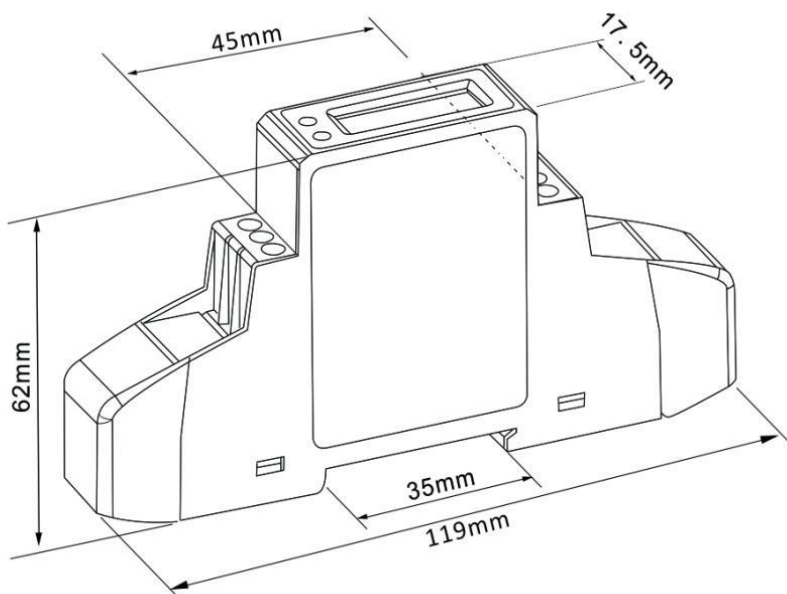

Installation

